



Vertical Stack

AVK10N3H2

CONTENTS

Key Features	3	Clearance	9
Technical Requirements	4	Technical Specifications	10
What's Inside	5	Dimensions	13
Airflow	6	Wiring Diagram	15
Installation	8	Warranty Terms and Conditions	16

KEY FEATURES

- **No outdoor unit**
The single package design means no outdoor unit, freeing up space on rooftops and at ground level and enabling installations in buildings without space for an outdoor unit.
 - **Twin rotary BLDC inverter compressor**
The state-of-the-art twin rotary BLDC inverter compressor operates efficiently, quietly, and with minimal vibration. AIO is ideal for any room or area that requires between 4,000 and 11,000 BTU.
 - **Integrated ERV**
AIO's integrated ERV eliminates the requirement of installing an independent ERV system, ducting, electrical work, and engineering.
 - **Recovery plus™**
With a patent pending innovation, AIO utilizes the heat or cold remaining in the air after passing through the recovery core to lower or raise the temperature of the condenser, enabling a boost in performance and efficiency.
 - **Integrated bathroom exhaust system**
The integrated stale air exhaust can be used for bathrooms and kitchens, maintaining perfect air pressure and eliminating a dedicated exhaust system. Bathroom exhaust can be field swapped to left or right.
 - **MERV 13 clean air**
Clean outdoor air is essential to well-being and safety. The MERV 13 filter ensures that all air entering the room/home is clean and safe. Additionally, stale air is passed through a second MERV 13 filter keeping the ERV core clean.
 - **High-efficiency ECM fans with auto ESP**
High-efficiency ECM fans enable efficient and quiet operation as the EC motor can ramp up or down depending on the need. Automatically adjusted external static pressure ensures correct airflow.
 - **Cold climate heat pump**
The heat pump will operate efficiently down to 5F, and will continue to operate at colder temperatures, even below -5F.
 - **1,800 Watt electric heat**
The electric heat works in conjunction with the heat pump when the heat pump has insufficient power.
 - **Intelligent defrosting**
AIO's intelligent defrosting system means more time heating and less time on reverse cycle defrost.
 - **Coil cooling system**
The condensate mister system drizzles the condensate on the outdoor heat exchanger coils, lowering the coil's temperature and increasing efficiency and performance.
 - **Quiet**
With whisper-quiet operation as low as 27 decibels, the occupant will barely notice AIO is operating.
 - **No outside noise infiltration**
AIO has the lowest STC and OITC rating among comparable units. This means less outside noise intruding into the room day and night.
 - **Versatile on/off options**
AIO's low voltage connection enables connection to any occupancy system, key-card, window sensors, fire alarms, etc.; as long as it can send a signal to AIO via low voltage, the unit can be easily turned on or off.
 - **Corrosion protection**
AIO comes standard with corrosion protection, assuring many years of trouble-free performance.
 - **Minimal clearances and compact footprint**
AIO's compact form with no line sets means there is no need to access the sides of the unit. Mount units with as little as 1/3 inch clearance on all sides. Compact footprints take up minimum space.
 - **Leak protection**
A drain alarm will activate if the drain becomes clogged, and the system will be shut off, preventing water damage.
 - **Easy to service**
AIO can be easily maintained and repaired from the front or bottom of the unit without having to remove the unit from the wall or ceiling. AIO can also be quickly swapped out with a replacement, reducing downtime.
 - **Versatile controls**
AIO includes an on board touch controller and an optional iOS and android app. AIO can be used with optional wall-mounted controllers, including a TFT with 7 day program and third-party controllers from any company using the optional 3rd party kit. An optional BACnet and Modbus module enables interfacing with building management systems
 - **10-Year limited warranty**
An industry-leading ten-year limited warranty provides peace of mind. Comprehensive onsite one-year parts and labor. Nine-year parts warranty on the compressor.
- Available extended on-site comprehensive parts and labor warranty for five, ten and 15 years.

TECHNICAL REQUIREMENTS

Site Requirements

Note: Refer to the full specifications for detailed information about the list of specifications.

- An electrical supply with a grounded 3-prong receptacle.
- The power supply circuit is installed in accordance with the current edition of NEC (ANSI/NFPA 70) and local codes and ordinances. Note: Always consult local and national electric codes.
- Voltage rating of 60 Hz, 208V/230V single phase.
- Properly installed insulated condensate drain line with a minimum of 30% slope if an external drain. An internal drain is highly recommended. If using an external drain on a low floor, ensure that end of drain is above the maximum height of snow buildup. An internal drain is highly recommended.
- Interior clearances are only required to prevent vibrations. Leave at least 1/3" of clearance from any surface. All others clearances are only dependent on ducting.
- Approved louvers installed with best practices to ensure no water into the wall assembly.
- Correctly sized ductwork, installed properly and balanced.
- The unit must be perfectly level on the vertical and horizontal axis.

- The unit must be tight to ducts, with zero leakage between the external ducts and the unit.
- Properly affixed screws to wall studs or other supporting material.
- Unblocked vents on the exterior with no obstacles within 36" of the air intake and discharge.
- An access panel with adequate clearance to be able to access the entire front of the unit for servicing.

Louver Specifications

AIO Vertical stack units can be vented through all kinds of custom and creative solutions. The possibilities are endless, from perforated panels to custom louvers.

There are two critical factors in selecting and sizing a solution that will work with AIO Vertical stack units.

- **Free area:** This area on a louver/grille is open for the air to flow through. The louver, perforated panel, or other solution must have at least the amount of free area as required in the specifications below in the plenum from the unit so that ample air can enter and exit the condenser chamber. A more restrictive solution with a smaller free area can be utilized by enlarging the louver and plenum until the required free area is achieved.

The minimum free area required is .34 sq feet for the intake vent and .34 sq feet for the exhaust vent.

- **Pressure drop:** Pressure drop is the resistance the louver/grille creates against the airflow. This resistance can create heat build-up inside the condenser portion, causing the compressor to overheat and shut down. A solution with a higher pressure drop than specified can be utilized

by enlarging the louver and plenum until the pressure drop is within specification.

The maximum total pressure for the intake and exhaust ducting (if any) and intake and exhaust louvers combined must be under 0.7" WC.

To be clear, the entire assembly of ductwork, plenums, and louvers for the complete air circuit, in and out of the system may not exceed 0.7" WC.

Any louver or louver or assembly must meet these requirements, as exceeding these limits can cause the unit to overheat and fail and void the warranty.

The following louvers are approved for AIO Vertical stack units:

- Sunvent: LLA/C, LLA/M, LLA/S - available through your Ephoca distributor.
- Thermaduct: RLA8- available through your Ephoca distributor.

WHAT'S INSIDE

- 1. Top supply air vent
- 2. Front supply air vent
- 3. ECM supply fan
- 4. Return vent
- 5. Fresh air ECM supply fan
- 6. Hybrid recovery core
- 7. Stale air ECM exhaust fan
- 8. Condenser + fresh air intake
- 9. ECM condenser fan
- 10. Condensate mister system
- 11. High efficiency outdoor heat exchanger
- 12. Condenser + stale air exhaust

- 13. Twin rotary inverter compressor
- 14. Electrical controls
- 15. Touch Controller
- 16. Condensate drain
- 17. Condenser + stale air exhaust
- 18. Condenser + fresh air intake
- 19. MERV 13 filter
- 20. Side Exhaust (Can be field swapped to the right side)
- 21. ECM supply fan
- 22. Return vent
- 23. High-efficiency indoor heat exchanger

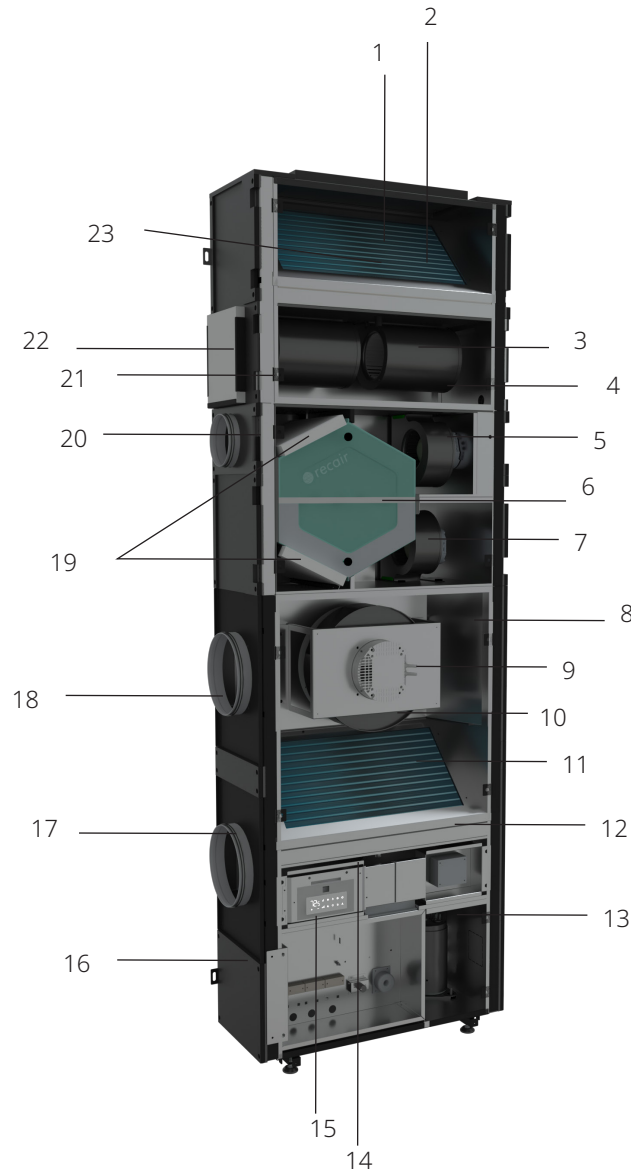

AIRFLOW

AIO vertical stack is extraordinarily flexible in the many ways it can be fully ducted or used with minimal or no ducting. This flexibility enables vertical stack to be placed anywhere in a dwelling with no restrictions.

- **Supply air**
The front, rectangular 6.7" x 18" supply air connection is ideal for a supply grille. With 0.6" WC external static pressure (combined between return and supply) the top rectangular 6.7" x 18" supply air connection is ideal for ducting to one or more rooms. For added flexibility, duct part through the top and direct vent part through the front for ducting multiple rooms with minimal ductwork.
- **Stale air exhaust**
The 5" round stale air exhaust connection can be used as part of a plenum return without any ducting or can be ducted to a bathroom or multiple locations with up to 0.5" WC external static pressure. Can be field swapped to the left or right side.
- **Return air**
The left and right side 6" WC round connection can be ducted to one or more rooms with up to 0.6" WC external static pressure (combined between return and supply). It can also be left open as a side plenum return. Each connection is fully independent with two ECM fans, each with auto ESP. Duct both, leave both open or duct one, and leave one open to a plenum.
- **Outside air intake**
The single 8" round outside air intake connection can be accessed from the left, right, or rear and provides outside air for the condenser portion and fresh air. This can be ducted with up 0.7" WC external static pressure (combined between intake and exhaust).
- **Outside air exhaust**
The single 8" round exhaust air connection can be accessed from the left, right, or rear, and exhausts the stale and condenser air. This can be ducted with up 0.7" WC external static pressure (combined between intake and exhaust).
- **Mix and match outside connections for total flexibility.**
The upper outside connection (left, right, and rear) is for exhaust, and the outside lower connection (left, right and rear) is for supply. It's possible to use any combination of connections. For example: Left for intake and rear for exhaust, or rear for intake, and right for exhaust, etc.

1.	Top supply
2.	Return
3.	Side intake
4.	Rear intake
5.	Rear exhaust
6.	Side exhaust
7.	Side exhaust
8.	Side intake
9.	Stale air exhaust (Can be swapped to the right side\)
10.	Return
11.	Front supply

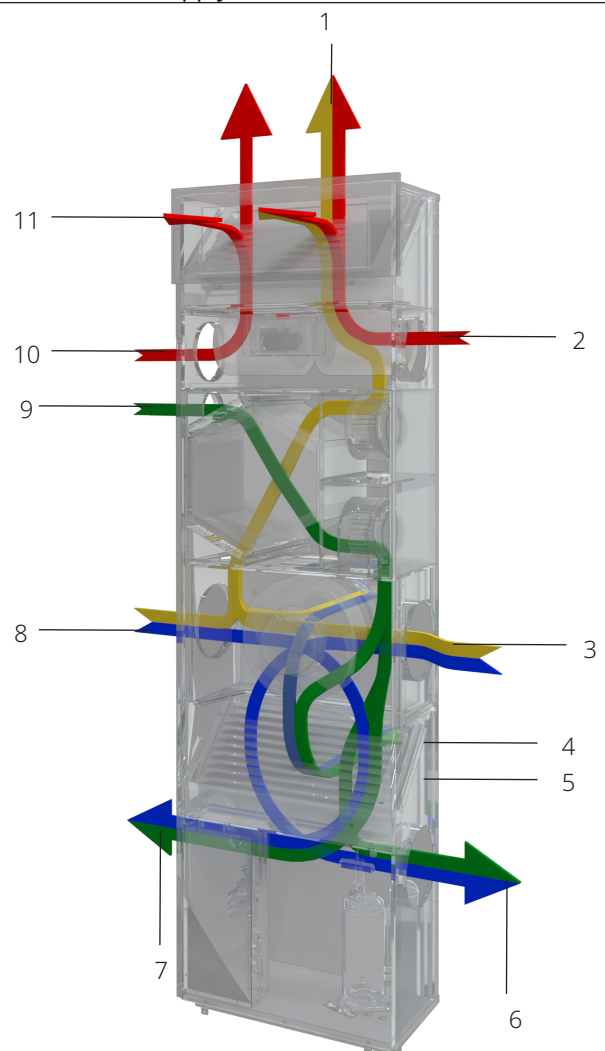

- Outside air
- Fresh air intake
- Recirculate air
- Stale air exhaust

Fan Coil Part

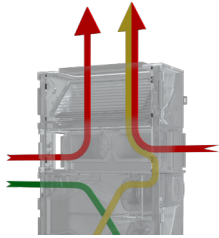

Supply: **Top**
Return: **Left & Right**
Stale Air: **Left**

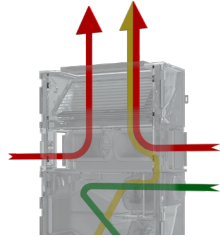

Supply: **Top**
Return: **Left & Right**
Stale Air: **Right**

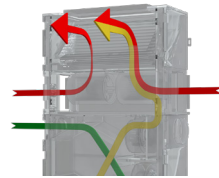

Supply: **Front**
Return: **Left & Right**
Stale Air: **Left**

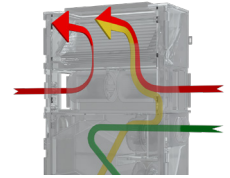

Supply: **Front**
Return: **Left & Right**
Stale Air: **Right**

■ Recirculate air ■ Stale air exhaust ■ Fresh air supply

Condenser Part

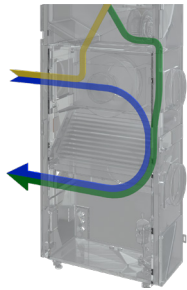

Intake: **Left**
Exhaust: **Left**

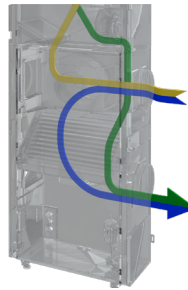

Intake: **Right**
Exhaust: **Right**



Intake: **Rear**
Exhaust: **Rear**

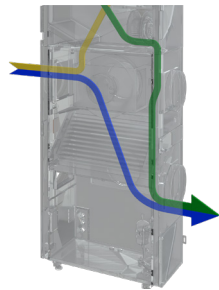

Intake: **Left**
Exhaust: **Right**

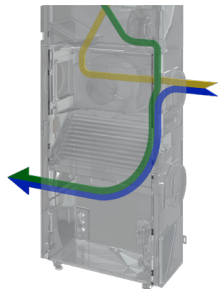

Intake: **Right**
Exhaust: **Left**

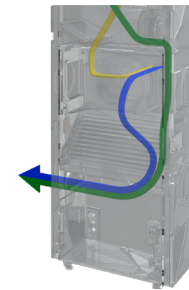

Intake: **Rear**
Exhaust: **Left**

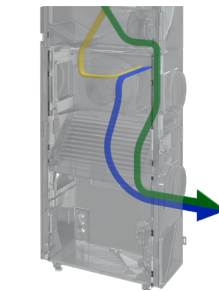

Intake: **Rear**
Exhaust: **Right**

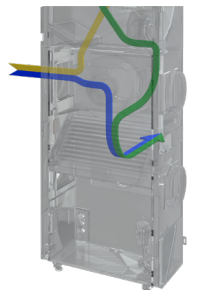

Intake: **Left**
Exhaust: **Rear**

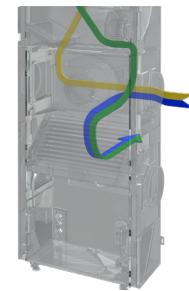

Intake: **Right**
Exhaust: **Rear**

■ Outside air ■ Fresh air intake ■ Stale air exhaust

INSTALLATION

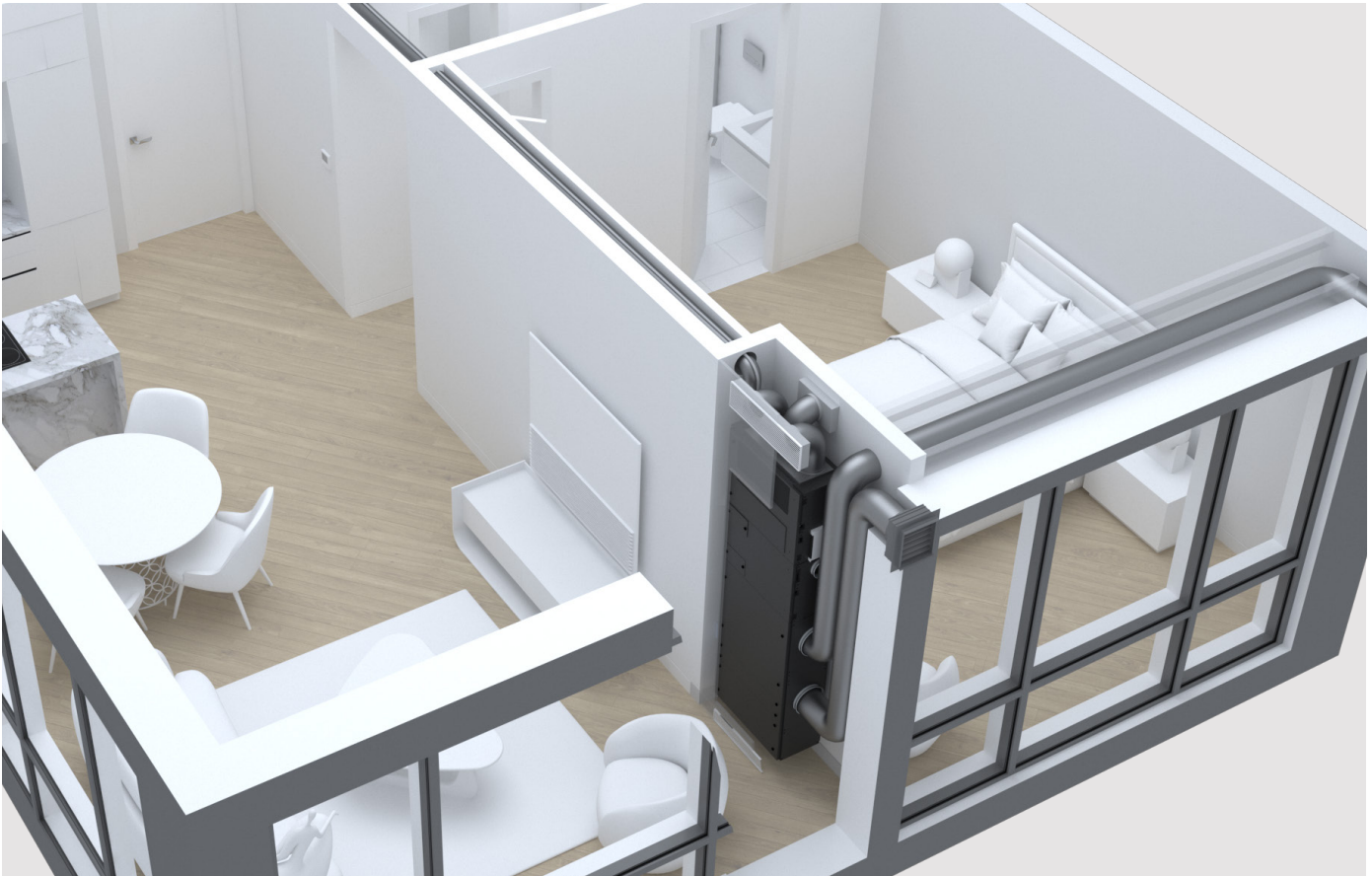

Left external vent



Right external vent

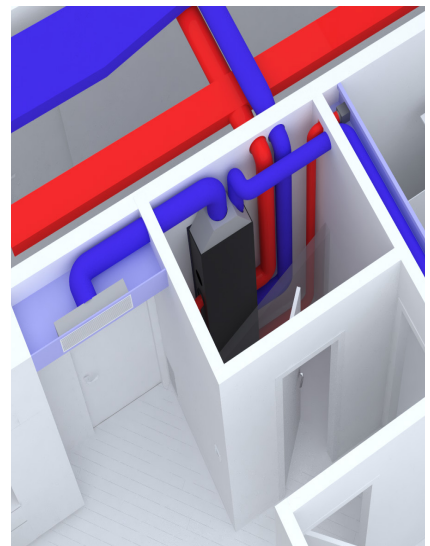

Shared supply and exhaust vents

CLEARANCE

The AIO Vertical Stack unit's clearance will depend on how it is vented. Please carefully read the criteria below to determine the correct clearance required.

- Ceiling**
 There must be 1" minimum clearance between the unit and ceiling to minimize noise from vibrations and for removing panels. If ducting through the top, ensure sufficient clearance to attach ductwork to the vent.
- Bottom**
 There must be a minimum of 1" clearance between the unit and floor to minimize noise from vibrations. The unit sits on adjustable leveling legs, which can be removed and the unit wall hung.
- Access Panel**
 There must be an access panel of at least the size of the unit plus 1/2 inch all around. The recommended size is 86 x 27. The minimum size is 84.5 x 26. You can integrate a return and supply grille into the access panel door.
- Sides**
 The clearance required on the sides is dependent on how the unit is configured for return and stale exhaust air.
- Side ducted return configuration**
 The clearance required is based solely on ductwork design. Ensure sufficient clearance to be able to attach the ductwork to the side return.

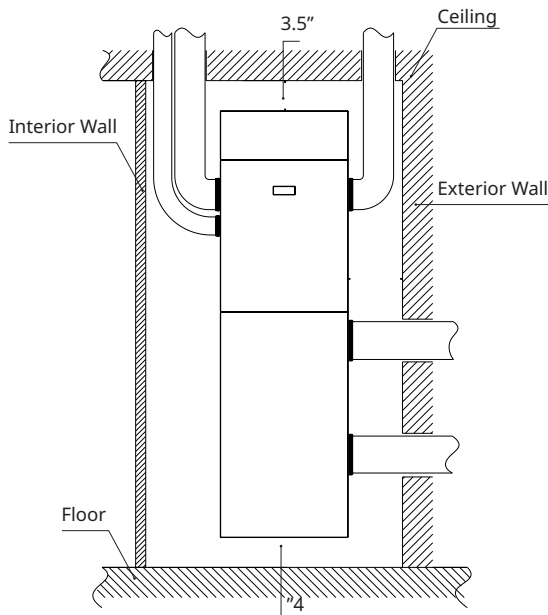

- Side plenum return configuration**
 A minimum of 2.5" should be free for airflow on each side to allow the air to flow into the returns.

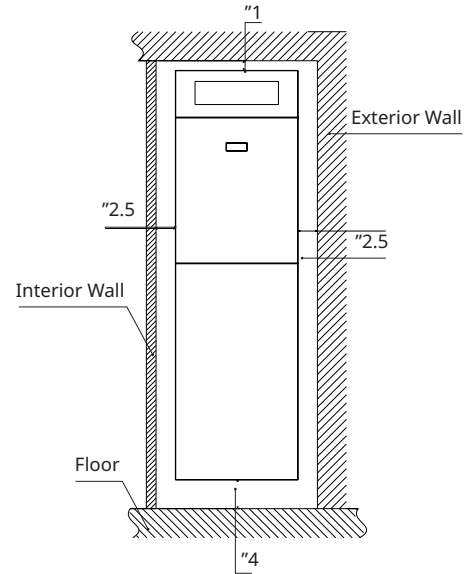

- Front**
 The clearance required in front of the unit to the access panel is 1/3" to minimize noise from vibrations.
- Rear**
 There must be 1/3" minimum clearance between the unit and wall to minimize noise from vibrations. If ducting the intake and exhaust from the rear, ensure sufficient clearance to attach the ductwork to the rear vents. Ensure that rear external vents do not have any barrier or wall for at least 40".

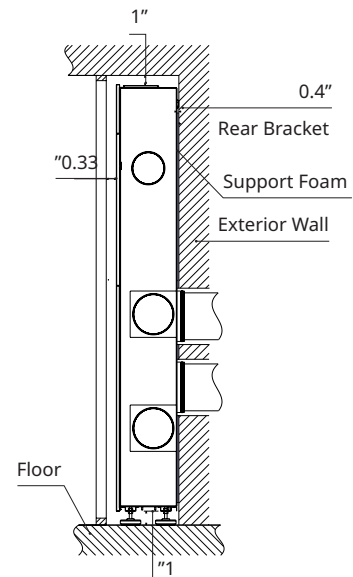

TECHNICAL SPECIFICATIONS

Cooling		95°F ¹	105°F ²	115°F ³
Heat Pump				
Maximum		15,000	13,000	12,000
Nominal	Btu/h	8,900	6,900	7,600
Minimum		3,400	3,400	3,400
Input Power	W	812	923	844
Efficiency		14.36 SEER2	9.00 EER2	7.47 EER2
Moisture Removal	Pts/h	1.9	-	

- 1 **95°F** Indoor: 80°F, W.B. 67°F; Outdoor: 95°F, W.B. 75°F
- 2 **105°F** Indoor: 80°F, W.B. 67°F; Outdoor: 105°F, W.B. 75°F
- 3 **115°F** Indoor: 80°F, W.B. 67°F; Outdoor: 115°F, W.B. 75°F

Heating		47°F ⁴	17°F ⁵	5°F ⁶	0°F ⁷	-5°F ⁸
Heat Pump (+ Optional 3,000 /6,100 BTU/H elec heat)						
Maximum		15,000	10,800	7,800	7,300	7,000
Nominal	Btu/h	8,300	9,000	6,500	6,100	5,800
Minimum		4,200	3,200	2,700	2,700	2,700
Input	W	664	1,146	1,107	1,070	1,036
Efficiency		9.81 HSPF2	2.3 COP2	1.72 COP2	1.67 COP2	1.64 COP2

- 4 **47°F** Indoor: 70°F, W.B. 67°F; Outdoor: 47°F, W.B. 43°F
- 5 **17°F** Indoor: 70°F, W.B. 60°F; Outdoor: 17°F, W.B. 13°F
- 6 **5°F** Indoor: 70°F, W.B. 60°F; Outdoor: 5°F, W.B. 3°F
- 7 **0°F** Indoor: 70°F, W.B. 60°F; Outdoor: 0°F
- 8 **-5°F** Indoor: 70°F, W.B. 60°F; Outdoor: -5°F

Airflow

Fresh air volume		
Indoor	Type	ECM centrifugal
	CFM	125-350
	Supply connection	Integrated front
	Return connection	Integrated bottom
	Speeds	Low, med, high, boost, auto
	Filter	MERV 3
Outdoor	Type	ECM centrifugal
	CFM	135-383
	Available ESP	0.7" WC
	Intake connection	8" round
	Exhaust connection	

General

Compressor		
Refrigerant	Type	R32
	Oz.	23.97
Oil	Type	Fv50s
	Type	BLDC twin rotary inverter

Controls	
Basic functionality	Dependent on controller
WiFi	Optional module available
Dry contact	Yes

Modes	
Operation	Cool+ fresh air, cool only, heat+ fresh air, heat only, auto
Restricted modes	Heat only, cool only, temperature limiting
Timers	Dependent on controller

Condensate		
Pipe	Size	3/4" Outside diameter
	Material	Rubber

Sound

Sound		
Indoor	dB(A)	27-43
	STC	40
	OITC	35
Outdoor	dB(A)	28-55

Dimensions

Physical data		
Dimensions	Net	41.4" W x 45.2" D x 11.6" H
	Net	170 lb
Weight	Gross	190 lb
	Finish	RAL 9003 signal white
Cabinet	Material	Steel

Electrical

General		
Volt range	180-253	
Hz/phase	60 Hz single phase	
Power supply	Hardwire or LCDI	
Power factor (%)	0.96	
Input power (standby)	W	10.8
Input power (off mode)		1.5
Cooling (nominal)		2.9
Cooling (max)	A	7.8
Heating (nominal)		10.6
Heating (max)		16.1

Motors			
Compressor	RLA	A	4.7
	LRA		
Indoor ECM fan motor	W (max)		180
	F.L.A.	A	0.8
	HP		0.24
Outdoor ECM fan motor	W (max)		190
	F.L.A.	A	0.8
	HP		0.25

Circuit breakers		
MCA		20
Recommended breaker size	A	25
MOCP		30

LCDI Power Cord		
Amps		20
Plug Type		6-20P

DIMENSIONS

With MERV 13 Filters for Indoor Recycled Air

For CAD and DWG files please scan or click the QR code below.

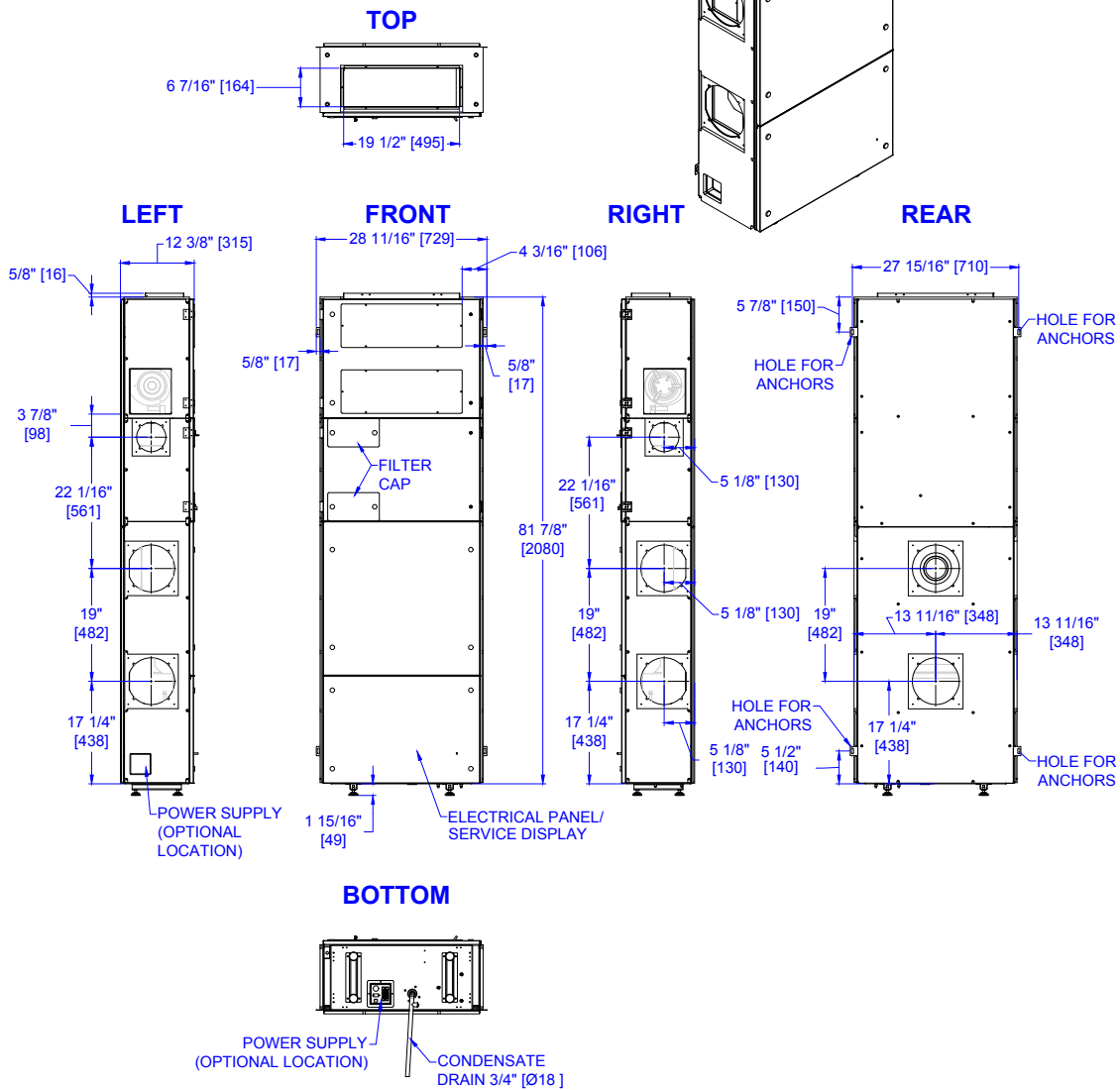
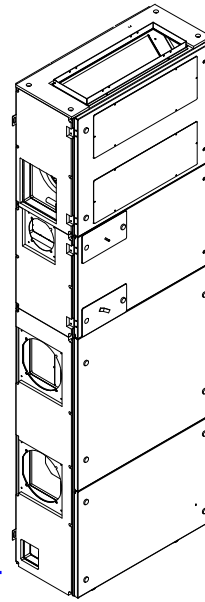

With Standard Filters for Indoor Recycled Air

For CAD and DWG files please scan or click the QR code below.

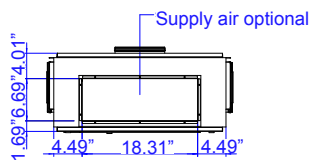
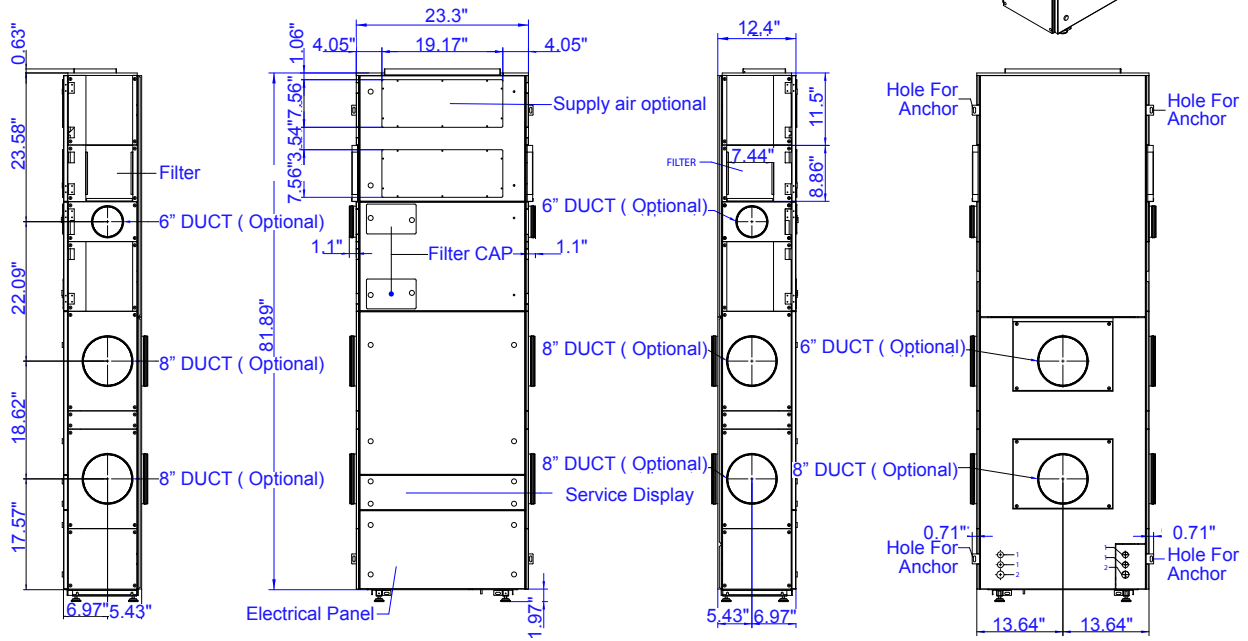
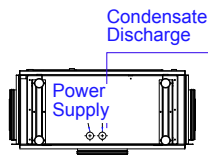
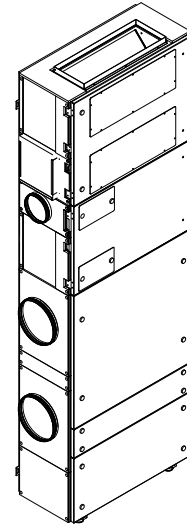

Notes

230V Electric Heat

DESCRIPTION

Digital inputs:

CN13	Door	Presence contact for terminals CP (presence contact)
CN15		Drain alarm

Analog Inputs:

ZE		Internal air quality sensor (placed on inlet air)
HU		Internal air Humidity and temperature Probes (placed on inlet air)
CN17	OT	External temperature probe (placed on external air inlet) NTC 5.28kΩ a 25~C.
CN17	OPT	Condenser probe (placed on pipe of external coil). NTC 5.28kΩ a 25~C.
CN7	IPT	Evaporator probe (placed on pipe internal coils). NTC 5.28kΩ a 25~C.
CN16	GT	Exhaust air probe (placed in exhaust air). NTC 5.28kΩ a 25~C.
XP209		Compressor discharge temperature probe. NTC 58kΩ a 25~C.

Digital outputs:

CN2	Valve	Reversing valve summer/winter
CN5	Heater	External heater (230VAC/5A)

Analog outputs:

CN23	Infan	Driving signal 0-10V external fan
CN9	Outfan_con	Driving signal 0-10V external fan
CN11	Display	Display touch connection

WARRANTY TERMS AND CONDITIONS

Ten Year Limited Warranty

This limited warranty is valid in the Continental United States only and only for the AIO series heat pump which was purchased and installed in its original installation location. This warranty is only valid when the AIO series heat pump air conditioner meets all the conditions below:

- Purchased from an Ephoca authorized distributor.
- Installed by an Ephoca certified technician.
- The installation was certified by an Ephoca technician before the AIO series heat pump was used.
- AIO is operated and maintained in accordance with the printed instructions in the user guide and in compliance with applicable local installation and building codes and good trade practices.
- The site must have a minimum of ten (10) units and there must be spare units on site equal to a minimum of three (3) units or 2.5% of installed units, whichever is greater.

These spare units must be used to replace a unit with a service issue until an Ephoca technician can be on site.

- A maintenance contract with a professional service provider must be in place to ensure the units are maintained and filters kept clean. You must submit documented filter cleaning every two months. You must submit documented annual unit cleaning.
- For any jobs sold with less than 10 units the distributor/ dealer is responsible for all labor costs and responsible for having attic stock for replacements.
- Every job must be inspected before turning on the units, and pictures of at least 10% of the units must be sent to our office. There are no exceptions. The warranty is not valid without a written letter from Ephoca after the installation pictures are reviewed per the self-certification process guide.

What This On-site Warranty Covers

Ephoca, Inc. ("Ephoca") warrants your AIO series heat pump air conditioner ("AIO") against failure due to defects in materials or workmanship under normal use, beginning on date

of certification by the Ephoca technician for the following periods:

Full One-Year Warranty

For the period of one year from the date of certification by the Ephoca technician, Ephoca will replace any part of the AIO which fails due to a defect in materials or workmanship. During this full one-year warranty, Ephoca will provide, on-site, free of charge, all labor and related service costs to

replace the defective part. If you are located in an area where we do not have Ephoca certified technician, we will ship you a replacement unit at our cost and arrange to pick up the defective unit at our cost.

Limited Ten-Year Warranty On Compressor

For the period of ten-years from the date of certification by the Ephoca technician, Ephoca will replace the compressor part should it fail due to a defect in materials or workman-

ship. During this limited ten-year compressor warranty, Ephoca will provide a replacement compressor, however, you will be responsible for all labor costs and related service costs.

Optional Extended Five, Ten and Fifteen Year Comprehensive Warranty

A comprehensive extended warranty is available for five, ten, and fifteen years from the date of certification by the Ephoca technician. During this extended warranty, Ephoca will replace any part of the AIO which fails due to a defect in materials or workmanship.

During this extended warranty period, Ephoca will provide, onsite, free of charge, all labor and related service costs to replace the defective part. If you are located in an area where we do not have Ephoca certified technicians, we will ship you a replacement unit at our cost and arrange to pick up the defective unit at our cost. Extended warranties must be

purchased directly from Ephoca within 90 days of installation. Controllers carry a two-year warranty; extended warranties exclude labor for wall controllers.



Exclusions and Limitations

The warranty shall not cover:

- Any AIO purchased from a non-authorized or out-of-state dealer.
- The extended warranty does not cover wall controllers.
- Any service, part or repair if AIO has not been certified Ephoca technician prior to use.
- Any failure due to or following unauthorized repairs, or repairs performed by unauthorized personnel.
- Installation of AIO, setup of user controls or adjustments to user controls.
- Instruction on user operation.
- Labor costs after the first year, or service trips to deliver or pick up parts not covered by the warranty.
- Replacement of fuses or circuit breakers, wiring or plumbing connections.
- Damage to AIO where there is a corrosive atmosphere containing any damaging chemical such as chlorine or fluorine (other than that normally occurring in a residential environment).
- Cleaning or replacing air filters.
- Removing AIO from inaccessible locations.
- Correcting improper installations.
- Any AIO not installed pursuant to applicable regional efficiency standards issued by the Department of Energy or other local rules and ordinances.
- Failure of AIO due to acts of God, natural disasters, power failures, interruptions, brownouts or power spikes, or due to incorrect inadequate electrical service or failure of Internet Services or Home Networks.
- Any AIO with altered, missing or defaced serial number.
- Damages or personal injury caused directly or indirectly by failure or malfunction of AIO as a result of any cause including natural disasters, accidents, misuse, improper wiring or installation.
- Any cost of supplemental (replacement) Cooling or heat during equipment failure.
- Any cost to replace, refill or dispose of refrigerant, including the cost of refrigerant.
- Any unit if a documented maintenance plan is not in place prior to installation.

Failure to meet any of these conditions will void the warranty:

- The unit must be in alignment with the intended room's design specification
- Submit documented filter cleaning every two months.
- Submit documented annual unit cleaning.
- Maintain attic stock of at least 3%, with a minimum of 5 units.

- Labor warranty applies only to orders of 10 units or more.
- Submit self-certification photos must be submitted to Ephoca at selfcertify@ephoca.com. Warranty activation requires review, approval, and issuance of a certification.
- Splicing low-voltage thermostat wires will void the warranty.
- Using any other wire (e.g. multi-strand) besides a solid copper C-Wire will void the warranty.
- Customer's account balance must be paid.

The warranty will be void if any of the following terms are not met:

- Self-certification photos must be submitted to Ephoca at selfcertify@ephoca.com. Warranty activation requires review, approval, and issuance of a certification.
- The unit must be used in alignment with the intended room's design specifications.
- Warranty is void if the customer's account balance remains unpaid.

THIS WARRANTY IS IN LIEU OF ANY OTHER WARRANTY, EXPRESS OR IMPLIED, INCLUDING WITHOUT LIMITATION, ANY WARRANTY OF MERCHANTABILITY OR FITNESS FOR A PARTICULAR PURPOSE. TO THE EXTENT ANY IMPLIED WARRANTY IS REQUIRED BY LAW, IT IS LIMITED IN DURATION TO THE EXPRESS WARRANTY PERIOD(S) ABOVE. NEITHER EPHOCA NOR ITS DISTRIBUTOR SHALL BE LIABLE FOR ANY INCIDENTAL, CONSEQUENTIAL, INDIRECT, SPECIAL, OR PRODUCTIVE DAMAGES OF ANY NATURE, INCLUDING WITHOUT LIMITATION, LOST REVENUES OR PROFITS, OR ANY OTHER DAMAGE WHETHER BASED IN CONTRACT, TORT, OR OTHERWISE. FOR A PARTICULAR USE OR PURPOSE.

NO ONE IS AUTHORIZED TO CHANGE THIS WARRANTY CERTIFICATE OR TO CREATE FOR US ANY OTHER OBLIGATION OR LIABILITY IN CONNECTION WITH THIS AIR CONDITIONER. NO OTHER WARRANTY, EXPRESSED OR IMPLIED, IS APPLICABLE TO THIS PRODUCT.

Some states do not allow the exclusion or limitation of incidental/ consequential damages or limitations on how long an implied warranty lasts, so the above exclusion or limitation may not apply to you. This warranty gives you, the original purchaser, specific legal rights; you may also have other rights that vary from state to state. This warranty does not cover any additional responsibilities or obligations not expressly stated herein nor does it apply to any accessory that is not a part of the AIO as included in the package by Ephoca.



Ephoca is the US subsidiary of Innova SRL - Via 1°
.Maggio, 8 - 38089 Storo (TN) Italy
ephoca.com | 216-710-1000